

MATCH LINE SHEET 6 OF 12

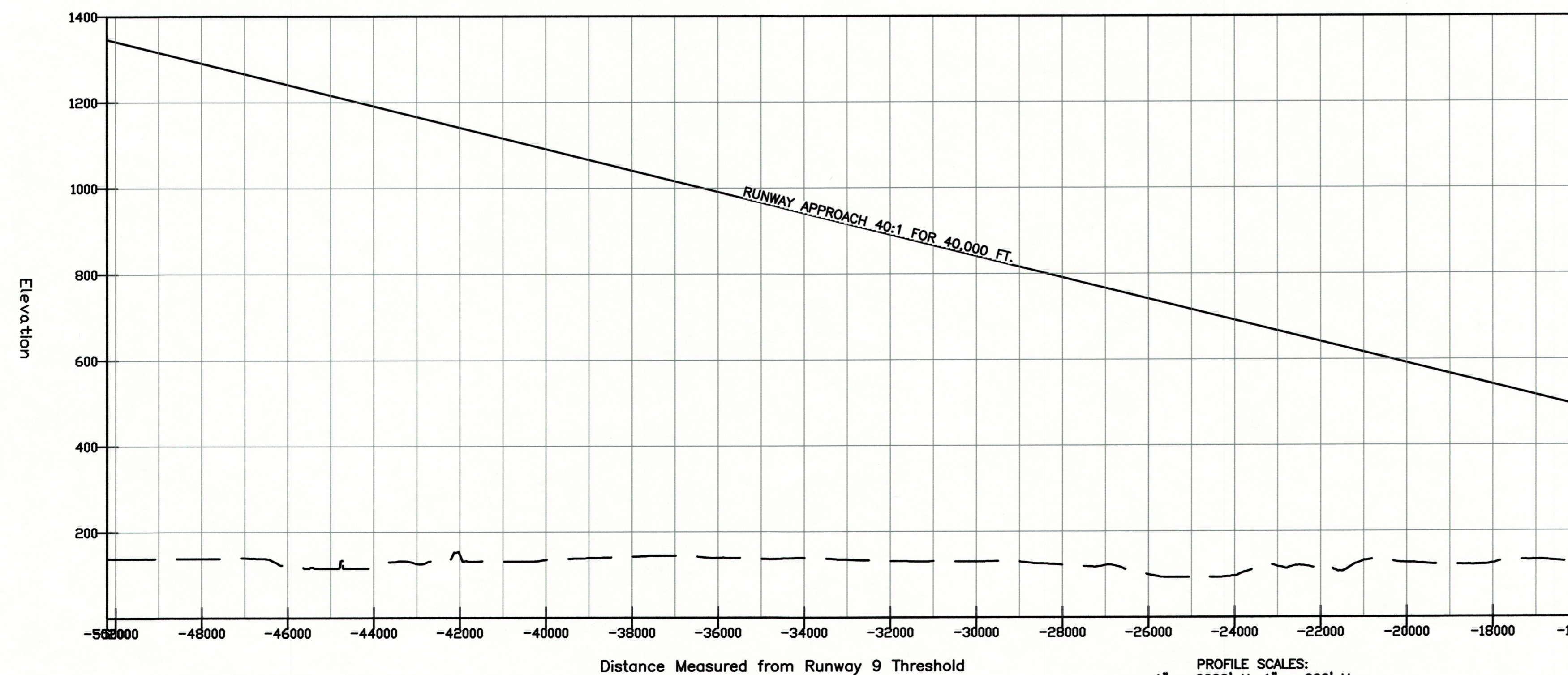

MATCH LINE SHEET 6 OF 12

RUNWAY 9/27

PROFILE SCALES:
1" = 2000' H; 1" = 200' V

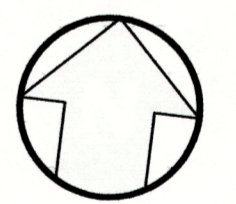

SCALE 1:24,000

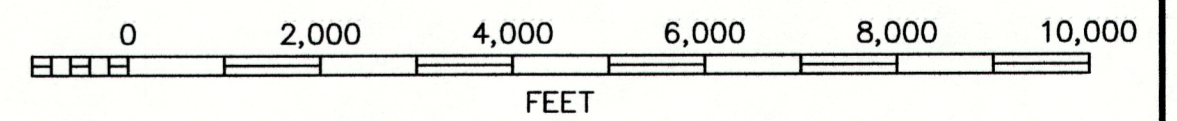
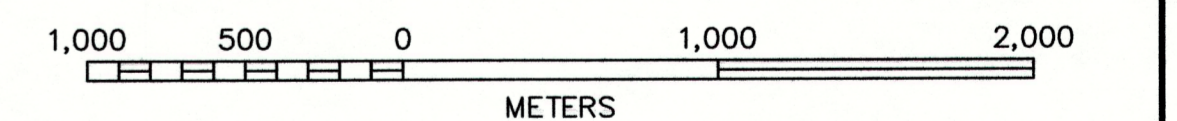

HORIZONTAL DATUM IS NAD83
VERTICAL DATUM IS NAVD88

NO.	REVISIONS	BY	APP.	DATE
 PEE DEE REGIONAL AIRPORT DISTRICT FLORENCE REGIONAL AIRPORT Florence, South Carolina				
Airspace Plan No. 1				
 <small>Post Office Box 1354, Irmo, South Carolina 29063-1354</small>				
DATE:	02/03/2009	SCALE:	1" = XXXX'	SHEET 5 OF 12

MATCH LINE SHEET 5 OF 12

MATCH LINE SHEET 5 OF 12

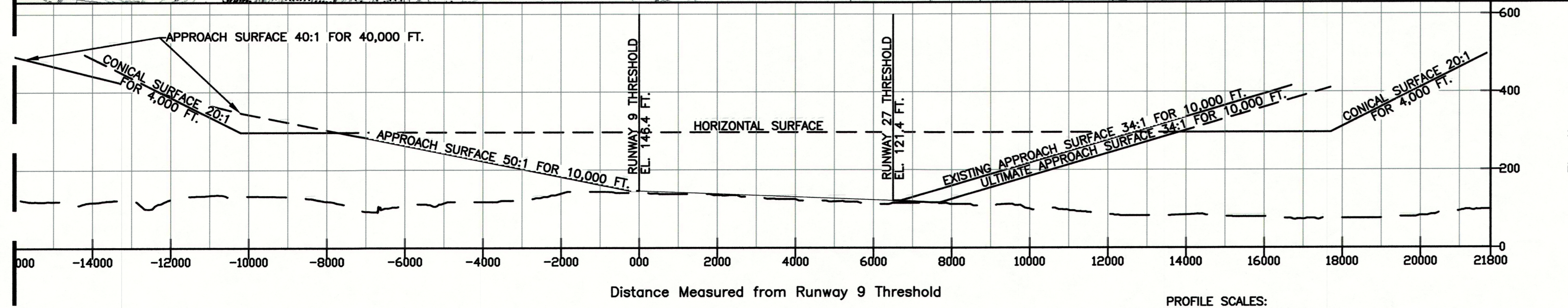
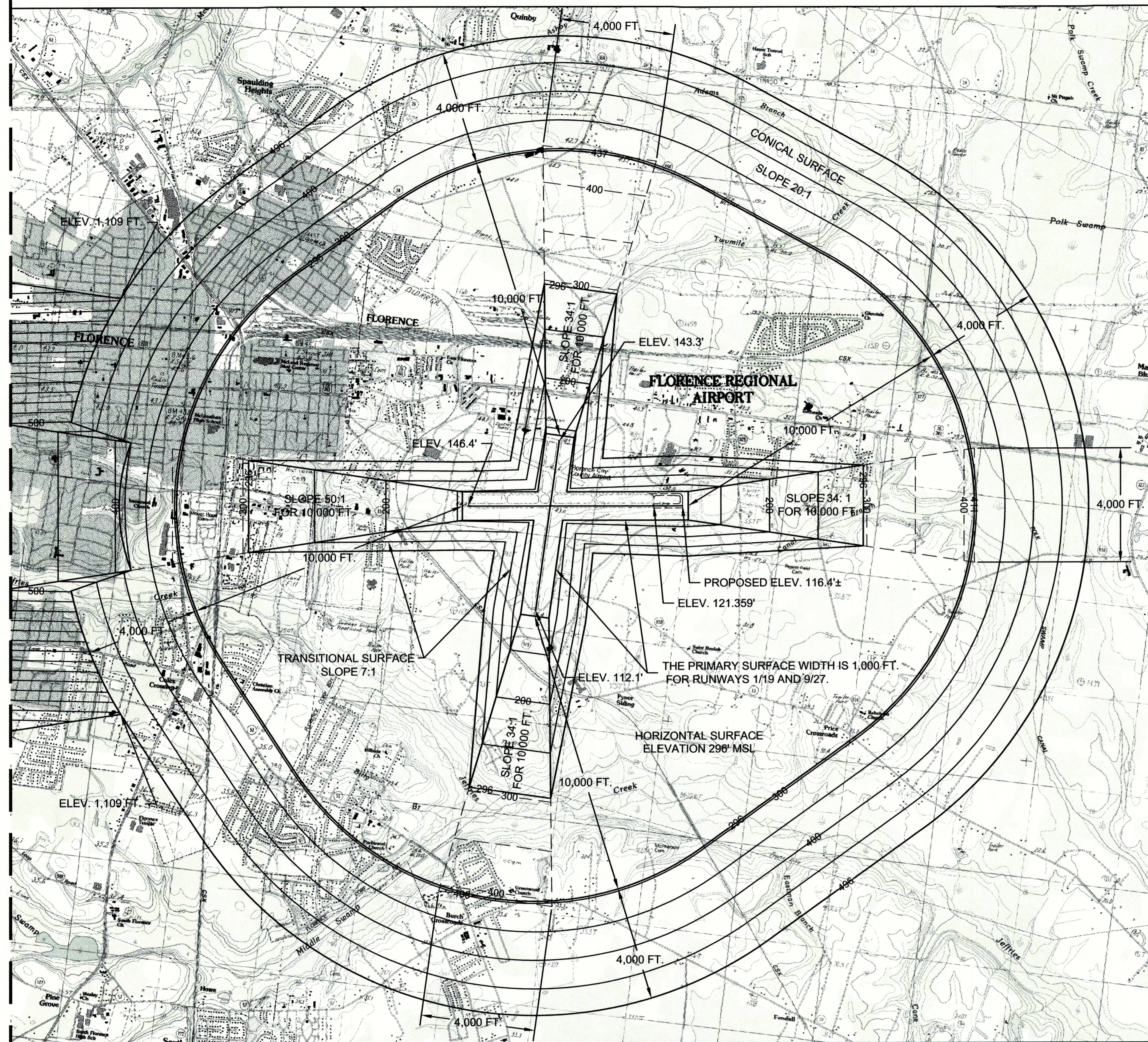

PROFILE SCALES:
 1" = 2000' H; 1" = 200' V
RUNWAY 9/27

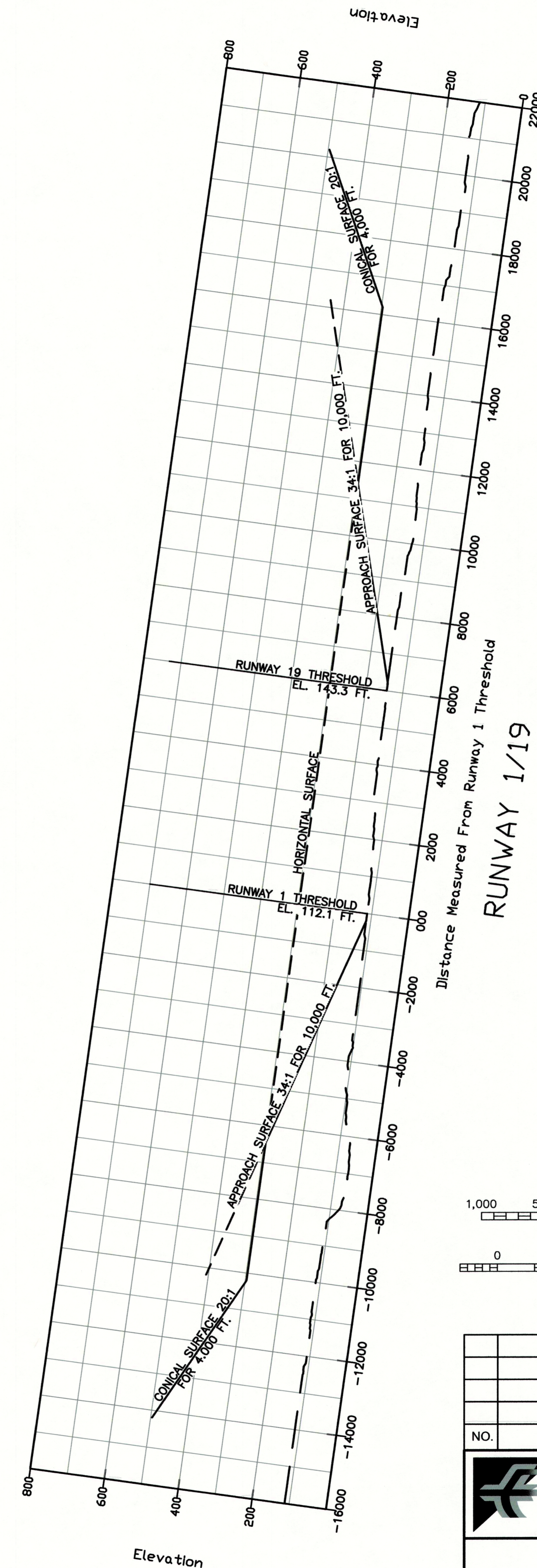

RUNWAY 1/19

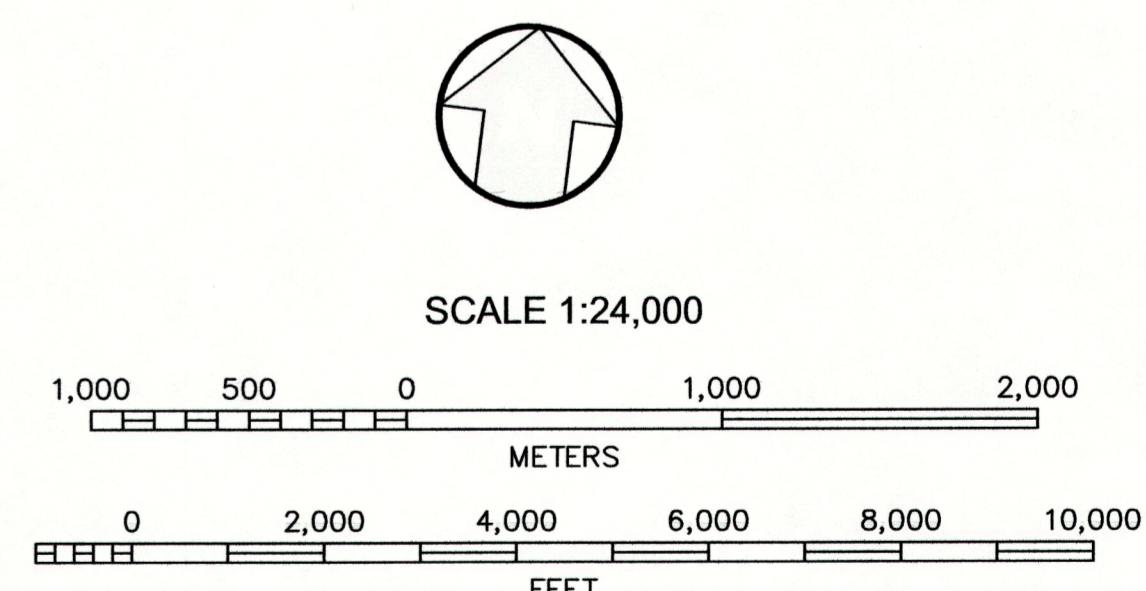

HORIZONTAL DATUM IS NAD83
 VERTICAL DATUM IS NAVD88

NO.	REVISIONS	BY	APP.	DATE
Airspace Plan No. 2				
<small>Post Office Box 1354, Irmo, South Carolina 29063-1354</small>				
DATE:	02/03/2009	SCALE:	1" = 2,000"	SHEET 6 OF 12